

# Data Sheet



Article number: 604144064030

Description: Timing belt pulley with hub  
HTD 64 8M 30

## Measures

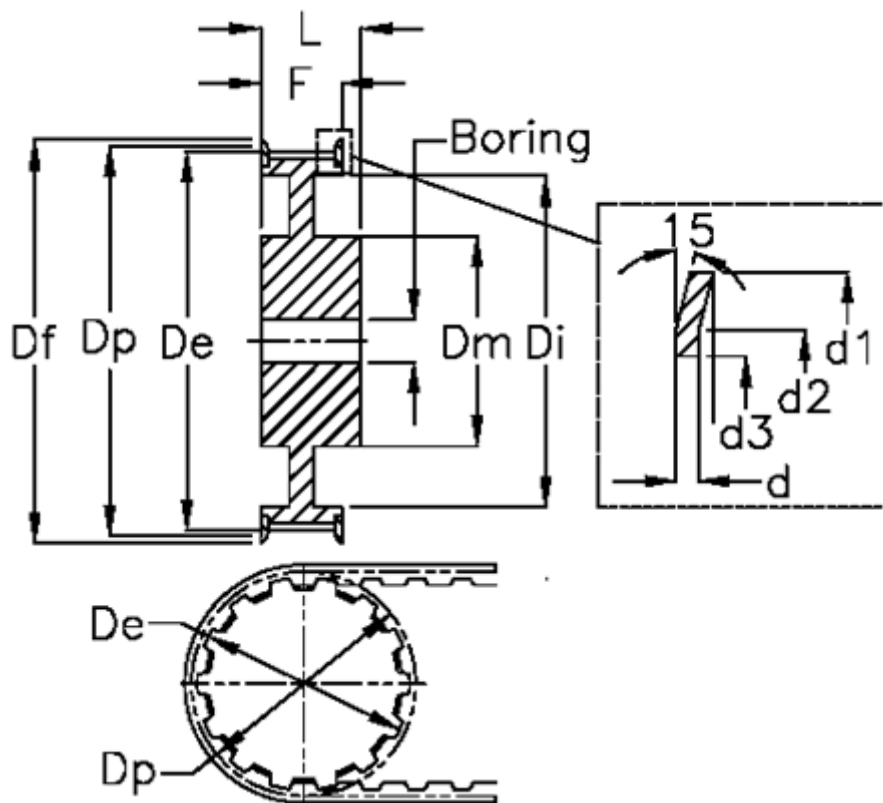

Bore = 15	Dm = 90	Width = 30
d = 1.5	Dp = 162.97	
d1 = 168	F = 137	
d2 = 161	Flange type = F52	
d3 = 148	L = 38	
De = 161.6	Tooth number = 64	
Df = 168	Type = 8M	
Di = 48	Weight = 4.3	